

Metal Film, Cylindrical Resistors



FEATURES

- Metal film resistor with high power rating
- Stable metal film on high quality ceramic
- Good thermal distribution
- Pure tin termination on nickel barrier, plated on press fit steel caps
- Compatible with lead (Pb)-free and lead containing soldering processes
- Lead (Pb)-free and RoHS compliant



STANDARD ELECTRICAL SPECIFICATIONS

MODEL	POWER RATING ¹⁾ P_{70} W	LIMITING ELEMENT VOLTAGE ²⁾ DC or AC rms V	TEMPERATURE COEFFICIENT ppm/K	TOLERANCE %	RESISTANCE RANGE Ω	E-SERIES
SMM0207	1.0	350	± 50	± 0.5	1R0 - 2M21	24 - 96
SMM0207	1.0	350	± 50	± 1	1R0 - 10M	24 - 96
SMM0207	1.0	350	± 100	± 5	R16 - R91	24

Zero-Ohm-Resistor : OMM0207 $R_{max} = 10 \text{ m}\Omega$ $I_{max} = 5 \text{ A}$

Note

1. Permissible dissipation depends on the maximum temperature at the solder point, the component placement density and the substrate material.
 2. Rated voltage: $\sqrt{P \times R}$.
- Further values and tolerances on request
 - Marking: According to IEC 60062; see also data sheet "surface mount resistor marking" (document number: 20020)
 - Zero ohm resistor has one black band only

TECHNICAL SPECIFICATIONS

PARAMETER	UNIT	SMM0207
Rated Dissipation at 70 °C	W	1
Limiting Element Voltage, DC or AC rms	V	350
Insulation Voltage (1 min), DC or AC peak	V	500
Thermal Resistance	K/W	see table
Insulation Resistance	Ω	$\geq 10^{11}$
Temperature Range	°C	- 55 to + 155
Failure Rate	$10^{-9}/\text{h}$	< 5
Weight/1000 pcs	g	77

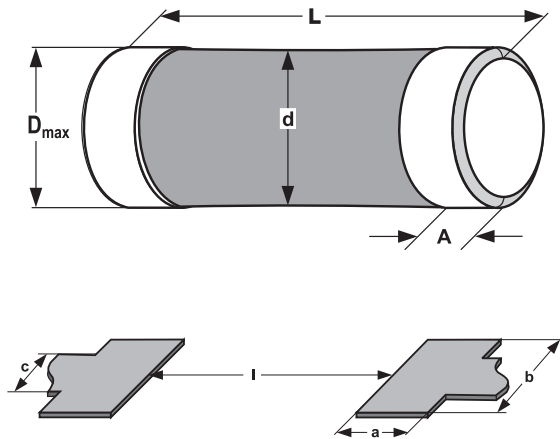
DIMENSIONS

MODEL	DIMENSIONS [in millimeters]				
	D _{max}	d*	L	A _{max}	A _{min}
SMM0207	2.2	D - 0.2	5.8 - 0.3	1.2	0.6

* d measured in the middle of the resistor

SOLDER PAD DIMENSIONS [in millimeters]					
a x b (mm)	LINE-WIDTH c (mm)	P ₇₀ for 35 μ (W)	R _{th} for 35 μ (K/W)	P ₇₀ for 70 μ (W)	R _{th} for 70 μ (K/W)
6 x 6	6	0.82	103	0.99	86
3 x 3	3	0.70	121	0.82	104
2 x 3	2	0.62	137	0.71	120
3 x 3	2	0.65	131	0.75	114
1 x 3	1	0.51	166	0.58	147
3 x 3	1	0.57	148	0.63	134
2.4 x 2	0.5	0.46	184	0.50	171
2.4 x 2	0.5	0.48	177	0.52	163

• Line length 30 mm min, l = 2.8 mm

PART NUMBER AND PRODUCT DESCRIPTION¹⁾

 PART NUMBER²⁾: SMM02070C5620FBS00

 PART NUMBER²⁾: OMM0207000000BS

S	M	M	0	2	0	7	0	C	5	6	2	0	F	B	S	0	0
O	M	M	0	2	0	7	0	0	0	0	0	0	0	B	S	0	0

MODEL/SIZE	SPECIAL CHARACTER	TC	VALUE	TOLERANCE	PACKING ³⁾	SPECIAL
SMM0207 OMM0207	0 = neutral	C = ± 50 ppm/K B = ± 100 ppm/K 0 = Jumper	3 digit value 1 digit multiplier 0000 = jumper MULTIPLIER 7 = *10 ⁻³ 2 = *10 ² 8 = *10 ⁻² 3 = *10 ³ 9 = *10 ⁻¹ 4 = *10 ⁴ 0 = *10 ⁰ 5 = *10 ⁵ 1 = *10 ¹ 6 = *10 ⁶	D = ± 0.5 % F = ± 1 % J = ± 5 % 0 = Jumper	BP BS	up to 2 digits 00 = standard

PRODUCT DESCRIPTION: SMM0207 50 562R 1% BS

PRODUCT DESCRIPTION: OMM0207 0R0 BS

SMM0207	50	562R	1 %	BS
OMM0207	-	0R0	-	BS
MODEL	TC	RESISTANCE VALUE	TOLERANCE	PACKING ³⁾
SMM0207 OMM0207	± 50 ppm/K ± 100 ppm/K	100R = 100 Ω 2M21 = 2.21 MΩ 0R0 = Jumper	± 0.5 % ± 1 % ± 5 %	BP BS

Note

1. Products can be ordered using either the PRODUCT DESCRIPTION or the PART NUMBER.
2. The PART NUMBER is shown to facilitate the introduction of a unified part numbering system. Currently, this PART NUMBER is applicable in the Americas only.
3. Please refer to table PACKING, see below.

PACKING			
MODEL	BLISTER TAPE ON REEL ACC. IEC 60286-3		
	DIAMETER	PIECES / REEL	CODE
SMM0207	180 mm/7"	1500	BP
OMM0207	330 mm/13"	7500	BS

• Further information about packing see also data sheet "surface mount resistor packing" (document number: 20014)

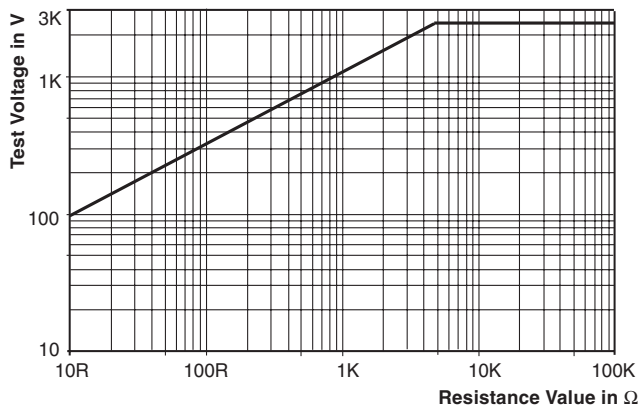
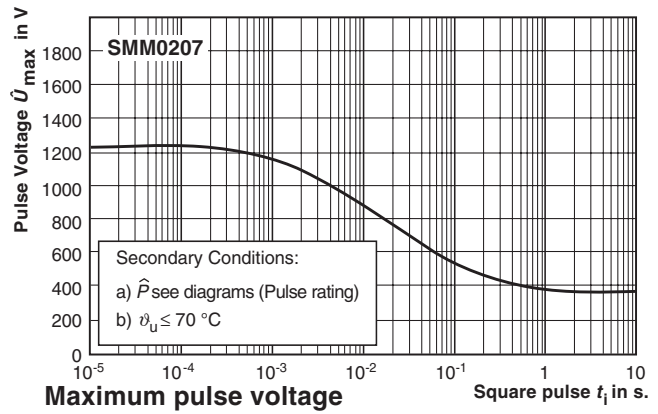
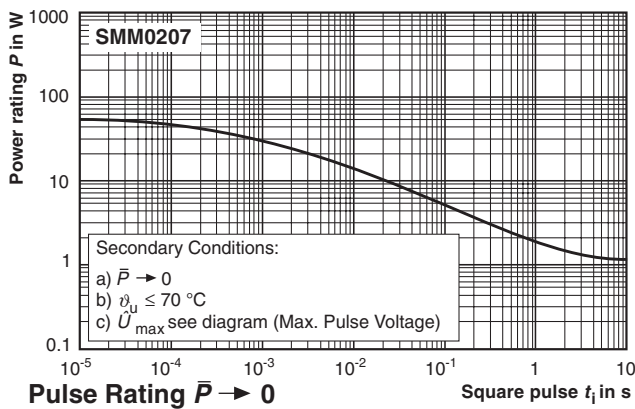
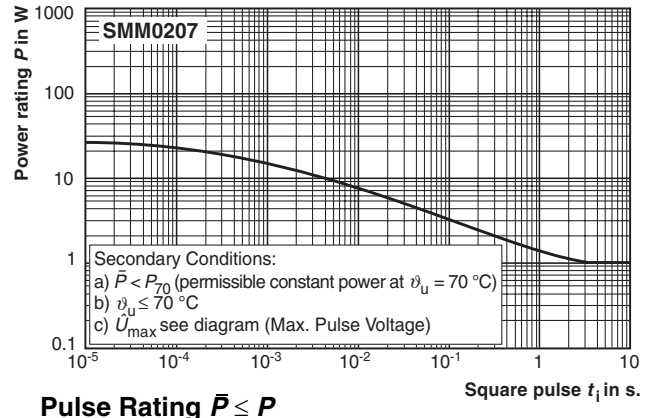
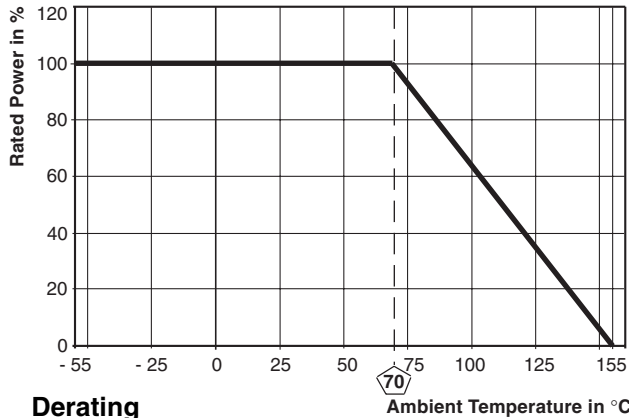

1.2/50 acc. EN 60115-1, 4.27

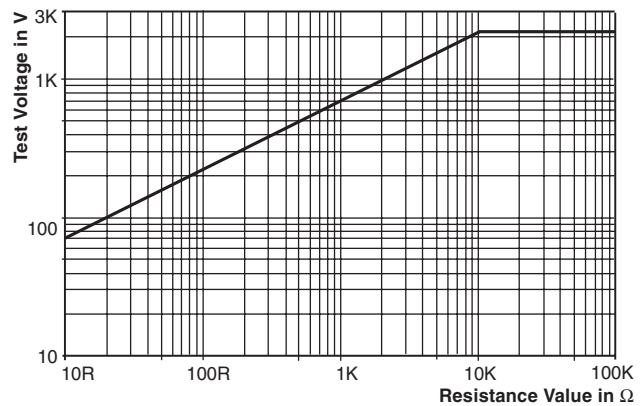

10/700 acc. EN 60115-1, 4.27

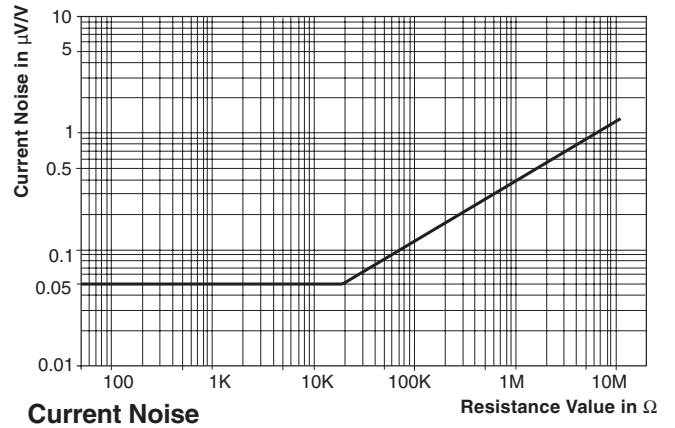
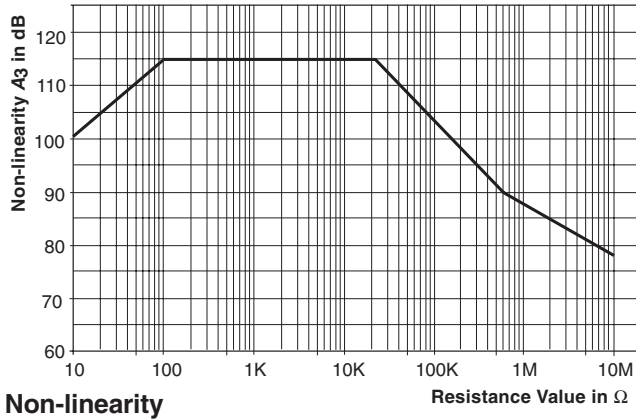

PERFORMANCE		
TEST	CONDITIONS OF TEST	TEST RESULTS ¹⁾
Endurance Test at 70 °C IEC 60115-1, 4.25.1	1000 hours at 70 °C 1.5 hours "ON" 0.5 hours "OFF"	≤ 0.5 %
Endurance at UCT IEC 60115-1, 4.25.3	1000 hours at 125 °C without load	≤ 0.5 %
Overload Test IEC 60115-1, 4.13	Short time overload for 2 seconds 2.5 x rated voltage or ≤ 2 x limiting element voltage	≤ 0.5 %
Thermal Shock IEC 60115-1, 4.19 and IEC 60068-2-14	Rapid change between upper and lower category temperature, 5 cycles	≤ 0.1 %
Damp Heat Steady State IEC 60115-1, 4.24 and IEC 60068-2-78	56 days at 40 °C and 93 % relative humidity	≤ 0.5 %
Resistance to Soldering Heat IEC 60115-1, 4.18 and IEC 60068-2-58	10 seconds at 260 °C solder bath temperature	≤ 0.25 %

Note

1. For a resistance range from 10 Ω to 1 MΩ.

APPLICABLE SPECIFICATIONS
<ul style="list-style-type: none"> • EN 140401-803 • EN 140400 • EN 60115-1



Notice

Specifications of the products displayed herein are subject to change without notice. Vishay Intertechnology, Inc., or anyone on its behalf, assumes no responsibility or liability for any errors or inaccuracies.

Information contained herein is intended to provide a product description only. No license, express or implied, by estoppel or otherwise, to any intellectual property rights is granted by this document. Except as provided in Vishay's terms and conditions of sale for such products, Vishay assumes no liability whatsoever, and disclaims any express or implied warranty, relating to sale and/or use of Vishay products including liability or warranties relating to fitness for a particular purpose, merchantability, or infringement of any patent, copyright, or other intellectual property right.

The products shown herein are not designed for use in medical, life-saving, or life-sustaining applications. Customers using or selling these products for use in such applications do so at their own risk and agree to fully indemnify Vishay for any damages resulting from such improper use or sale.